

See the **extended user guide** – for more information about using your frame, visit www.kodak.com/go/digitalframesupport. See the frame package for package contents.

Front View

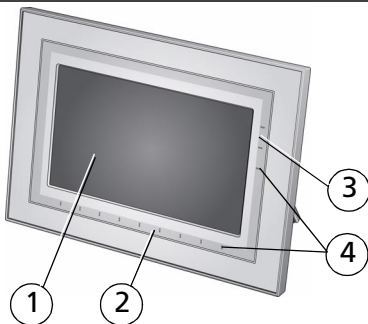



- 1 LCD screen
- 2 Quick Touch border (bottom, tap/slide)
- 3 Quick Touch border (right side, tap only)
- 4 LED lights

NOTE: When screen icons appear, LED lights turn on at touch-sensitive points along the Quick Touch Borders.

To use the touch border, see page 4.

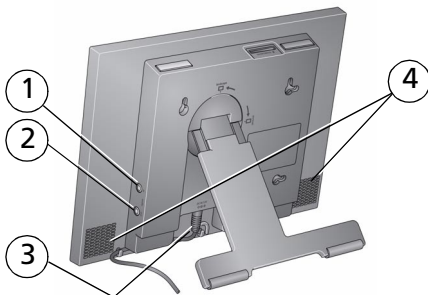
Back/Right View



- 1 Audio In
- 2 Audio Out 
- 3 DC-In (12V) 
- 4 Speakers

Back/Side View

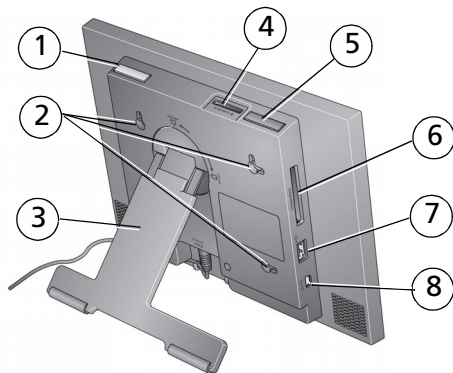

1 Power button

2 Wall mounting holes

3 Rotating/extending stand

4 Memory card slot - SD, MMC, MS, xD

5 Volume button

6 Memory card slot - CF, MD



7 USB connector (to camera/USB device)

8 USB connector (to computer)

1

Getting started

Setting up the stand; attaching the power cable

Your frame is set up to display pictures in landscape  orientation. You can turn the stand to change it to portrait  but you must also change the setting (see the extended user guide).

Stand (pull out to adjust the frame angle)

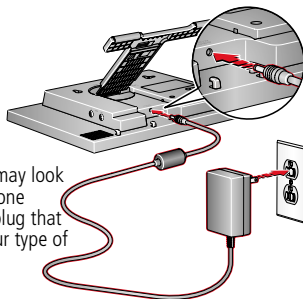
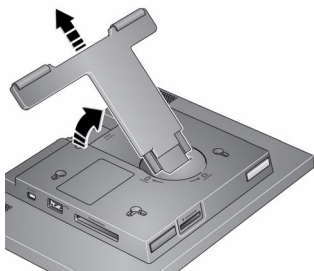

Your power cable may look different from the one pictured. Use the plug that accommodates your type of power outlet.

Turning on your frame

Power button- press and hold for 2 seconds, then release.

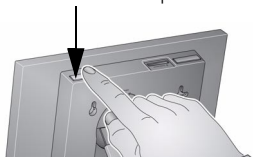

Using your frame's Quick Touch Borders

Touch tips

Tap and slide on the Quick Touch Borders* only.

- **Tap** a border to display the icons. Tap Close to dismiss them.
- **Tap** the light closest to a button to select it.
- **Slide** to highlight menus, pictures, videos, options. ** Tap OK to select them.
- **Don't hover**, borders can be sensitive.

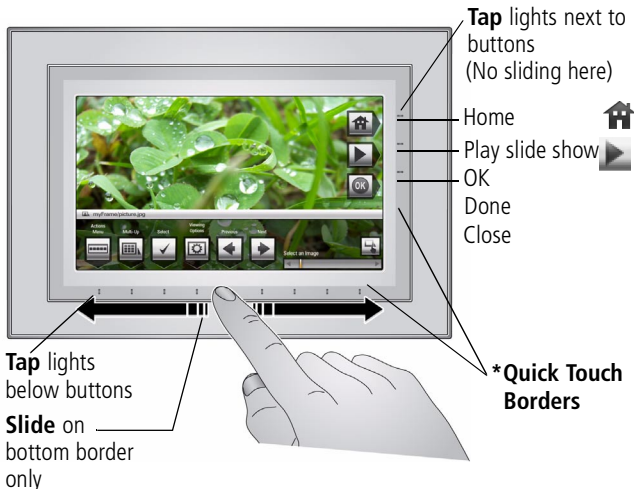

Slide to scroll:

- Scroll through images—Like turning the pages of a book, slide left ← to go forward, slide right → to go back. For faster scrolling through larger numbers of pictures, touch and hold (3 seconds), then slide to the end of the border.
- Scroll through menus—Slide right → to scroll down, slide left ← to scroll up.

** **Tap below small arrows at the ends of the scroll bar** to move the highlight one picture, menu, or item at a time.

IMPORTANT: The screen is not touch-sensitive. Do not touch it.

Only use your finger to touch the borders. Sharp or metal objects may damage the border or screen.

Setting your language

The language screen appears the first time you turn on your frame.

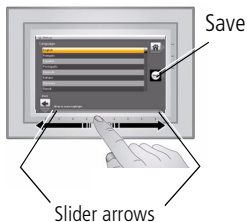

- Slide (or tap below slider arrows) on the bottom border to highlight your language, then tap Save.

NOTE: Slide left/right on the lights to move up or down the list.

To change the language at a later time:

- Tap  (Home) →  (Settings) → Language.

The language screen appears.

Slide to highlight your language, then tap Save.

Connecting to your wireless network

After you set your language, your frame scans for available wireless networks. See [Connecting to your wireless network, page 7](#).

Enjoying your pictures immediately!



- **To view your pictures or play a slide show**, insert a memory card, or connect a camera or other USB device (see [page 6](#)). Your pictures play automatically.

If your frame has preloaded sample pictures, they start playing automatically.

Inserting a memory card

- To insert a card, push the card firmly into the slot until it stops.
- To remove a card from:
 - top card slot, push in the card to release it.
 - side card slot, pull out the card

IMPORTANT:

Do not insert a micro or mini memory card without an adapter.

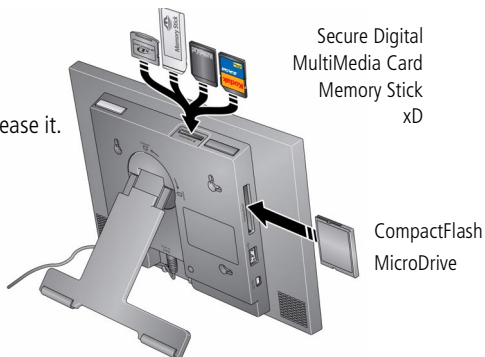

Connecting a digital camera or other USB device

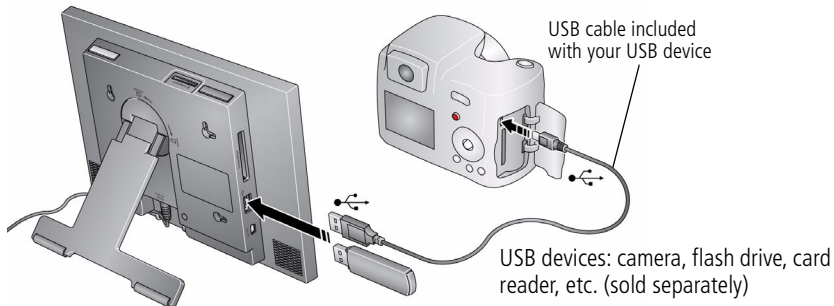

2

Setting up for wireless operation

If you have problems with your wireless setup or connection, see Troubleshooting starting on [page 22](#). Or open EASYSHARE Digital Display Software on your computer (see [page 11](#)) and click Tools → Wireless Troubleshooter. Follow the automated troubleshooting wizard.

Connecting to your wireless network

To allow your frame to access the contents of your computer wirelessly, connect your frame to your wireless home network.

NOTE: If you are not sure you have a wireless network, ask the person who set up your computer.

- 1 First time—If this is the first time you turned on your frame, tap Save after you set your language ([page 5](#)).

The Scanning for available wireless networks... screen appears.

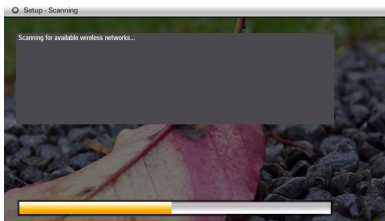

Setting up for wireless operation

Available wireless networks are listed.

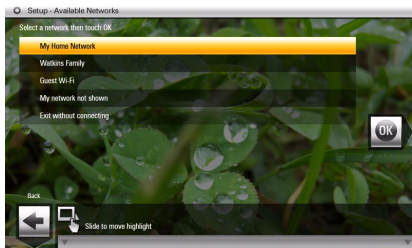

NOTE:

If the scan finds multiple networks, your home network (with the highest % signal strength) is usually listed first and highlighted.

Or, to select another network, slide or tap below the arrows to highlight a network, then tap OK.

Tap Back to dismiss the screen and connect later.

Later—To connect later, tap Home  → Settings  → Network → Scan for wireless networks. Then follow the screen prompts and continue with step 2 below.

If your wireless network is not found, select Scan again. You may need to enter the network SSID (sometimes called the network name) manually. The person who set up your network can help you with this information. Or, tap Help me connect for more information.

- 2 With your home network highlighted, tap OK to connect to your home network.

The Connecting... screen appears.

Or, select Exit without connecting and go to the Home screen ([page 14](#)).

Enter security key (if you have security enabled)

If you have wireless network security enabled, you are prompted to enter your security key (WEP or WPA) on the on-screen keyboard. Slide along the bottom of the

touch border (or tap below slider arrows) to highlight a character then tap  (Select) to enter it in the text box. Tap Done when finished.

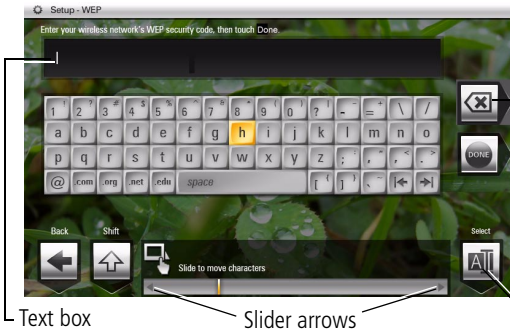

Navigation tip:

Keep sliding (or tapping arrows) left/right to go to the previous or next row.

Backspace - erases text

If you do not have security enabled, go to step 3.

NOTE: The screen identifies your security as either **WEP** or **WPA**.

A **WEP** security key can be either:

5 or 13 characters (0-9, A-Z, some special characters, case sensitive),

10 or 26 characters (0-9, A-F, not case sensitive).

A **WPA** key is 8-63 characters, case sensitive.



The person who set up your network can provide you with this information.

Congratulations! You have successfully connected to your network. Return to this screen later to make sure the wireless network and software are working properly.

- 3 If you haven't done so already, install the KODAK EASYSHARE Digital Display Software (see [page 10](#)) so your frame can display wireless content properly.

Installing the software

The CD that was packaged with your frame contains two applications that work well independently, but also work together for the best experience with your frame:

- KODAK EASYSHARE Digital Display Software —manage your frame, copy between your frame and computer, and set up your frame for access to KODAK Gallery and Web content ([page 12](#)).
- KODAK EASYSHARE Software —organize, edit, and share your pictures.

IMPORTANT: *We recommend that you install both. If you already have EASYSHARE Software on your computer, upgrade to this special version for additional features.*

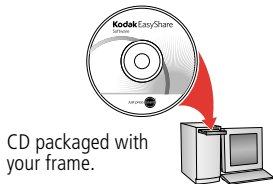

- 1 Insert the CD into your computer.
- 2 Follow the on-screen instructions to install the software.
 - Click Typical to install EASYSHARE Digital Display Software and to update a previous version of EASYSHARE Software.
 - If you do not have a previous version of EASYSHARE Software on your computer, you can click Custom and choose both applications for a new installation.

The software icons appear on your desktop when the installation is complete.

- 3 Double-click  to open EASYSHARE Digital Display Software if it doesn't open automatically.

When prompted, take a few minutes to electronically register your frame and software for exclusive tips and offers. To register later, visit www.kodak.com/go/register.

Using the software

Install the software that was packaged with your frame ([page 10](#)) on any computer that you want your frame to connect to wirelessly. Then double-click the EASYSHARE Digital Display Software icon  on your computer's desktop to open the software.

Click Help in the menu bar for more information on using the software.

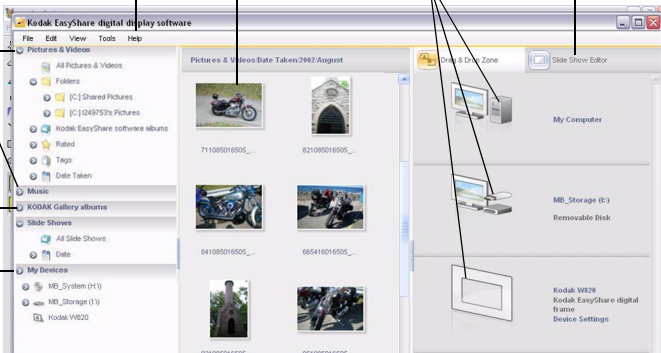

Choose picture source:

Pictures, videos, music on your computer

KODAK Gallery albums

Your frame and connected devices

Click Help for more info

View and select pictures here

Drag and drop here

Click here to create a slide show

The screenshot shows the 'Kodak EasyShare digital display software' window. The left sidebar contains a navigation tree with categories like 'Pictures & Videos', 'Music', 'KODAK Gallery albums', 'Slide Shows', and 'My Services'. The main area displays a grid of image thumbnails. The top menu bar includes 'File', 'Edit', 'View', 'Tools', and 'Help'. On the right side, there are buttons for 'Slide Show Editor' and 'My Computer'. Annotations with arrows point to various elements: 'Choose picture source:' points to the sidebar; 'Pics, videos, music on your computer' points to the 'Pictures & Videos' folder; 'KODAK Gallery albums' points to the 'KODAK Gallery albums' folder; 'Your frame and connected devices' points to the 'My Services' section; 'Click Help for more info' points to the 'Help' menu item; 'View and select pictures here' points to the main image grid; 'Drag and drop here' points to the 'My Computer' area; and 'Click here to create a slide show' points to the 'Slide Show Editor' button.

Setting up access to Gallery and Web content

On your computer, use EASYSHARE Digital Display Software (page 11) to set up access to Web content such as your KODAK Gallery account, frequently changing RSS (Really Simple Syndication) photo feeds, music, or videos.

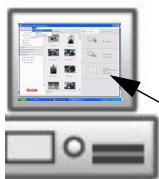

- 1 Make sure your computer is connected to the Internet.
- 2 Click  on your desktop to open EASYSHARE Digital Display Software.
- 3 In the Menu bar, select Tools → Device Settings (also available in the Drag and Drop Zone).
- 4 From the pull-down menu, select your frame.
Your frame's Configuration Web page opens in your browser.
- 5 Click the following for on-screen setup instructions:
 - Web Media - KODAK Gallery, Flickr, news, weather, sports, etc. from FrameChannel, custom RSS feeds, and shortcuts to favorite feeds for easy access on the Home screen
 - Settings - customize your frame right from your computer

To view Web content on your frame, see [page 14](#).

Verifying computer/device connections

After installing the software (page 10) and setting up access to Web content (page 12), return to the Network Connection screen on your frame (see page 8).

1 Tap Scan now.

The Scanning screen appears as the frame scans your network and then lists available computers and other picture sources that your frame can access wirelessly.

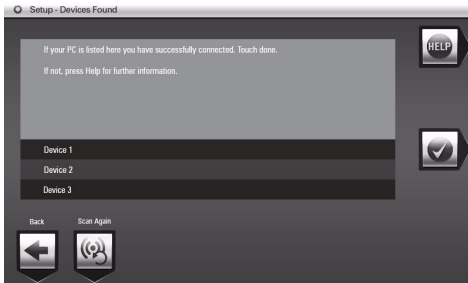

NOTE:

Select Scan later to verify later that your frame can access available devices wirelessly.

To verify later, tap  (Home) → Settings → Network → Verify computer connection.

If your computer is listed, your wireless setup is successful. Tap Done.

If your computer is not listed, tap Scan again or tap Help for options.

2 Tap Done to close the window and return to the Home screen.

Your frame can now access the content on your host computer, wirelessly. Your computer appears as a picture source icon  on your frame (see page 16).

3

Doing more with your frame

Viewing the Home screen/Web content

Start at the Home screen to:

- access your pictures, videos, and music.
- play slide shows of Web content (KODAK Gallery, Flickr, FrameChannel RSS feeds) you set up (see [page 12](#)) and preloaded ones such as weather, sports, news, etc.
- receive pictures from your friends and family at KODAK Gallery (see [page 20](#)).
- customize your viewing through the Settings screens.



- 1 Tap  (Home). If the icons are not visible, tap the Quick Touch Border.
- 2 Tap the light below one of the icons along the bottom of the screen.
- 3 Tap Close to dismiss the icons.

Home screen icons:



Pictures and videos (see [page 16](#)).



Music (see [page 19](#)).



KODAK Gallery—appears if you set up access to KODAK Gallery (see [page 12](#)). Display your Gallery albums and My Friends' Albums. This icon () indicates someone has shared pictures with you at the Gallery! See [page 20](#).



Web media—list of Flickr and FrameChannel RSS photo feeds you set up (see [page 12](#)).

Feeds you set up as favorites for easy access (see [page 12](#)) appear on the list and as shortcuts on the Home screen.



Preloaded feeds (such as news, weather, sports, finance, etc.) that you can edit using the EASYSHARE Digital Display Software (see [page 12](#)).





Settings—customize frame settings such as slide show durations and transitions, slide show options, screen brightness, clock, and timer.

For details, see the extended user guide at www.kodak.com/go/digitalframesupport.

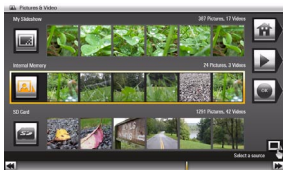
Accessing your pictures and videos



- 1 Tap  (Home), then  (Pictures and Videos).
All connected sources (see below) are displayed.
- 2 Slide or tap below the arrows to highlight a picture source, then:
 - Tap  (Play slide show) to start a slide show of the pictures in the highlighted source.
 - Or, tap OK to view thumbnails, folders, etc.

Picture sources:



My Frame—the frame’s 512 MB internal memory. Copy your pictures into My Frame from a memory card or other device.



Memory card—appears when you insert a card ([page 6](#)). The label and icon indicate the type of card.



Camera—appears when you connect a digital camera via USB cable ([page 6](#)).



USB drive—appears when you insert a USB flash drive ([page 6](#)).



Network computer—appears if you are connected to a wireless network computer (see [page 7](#)). Display pictures that are stored on the computer.



My Slide show—appears when you save a favorite slide show source for quick access anytime (see [page 18](#)).

Viewing pictures and videos



View pictures and videos from any connected picture source (see [page 16](#)).

IMPORTANT: *For wireless access, make sure you set up your frame to work with your wireless home network (see [page 7](#)).*



View a single picture and thumbnails

To view a single, full-screen picture, highlight it in thumbnails view, then tap OK.

To view your pictures as thumbnails:

- Tap  (Home) →  (Pictures and Videos). Slide to highlight a picture source, then tap OK.
- Or, from a slide show or single view, tap  (Thumbnails).

Tips when viewing the thumbnail screen:

- To navigate through the thumbnails, slide your finger left/right along the slider at the bottom, or tap below the slider arrows to move one picture at a time. To move even faster through the thumbnails, touch and hold until the screen changes (about 3 seconds).
- To play a whole folder of images, highlight the folder then tap  (Play slide show).
- To play a video from thumbnails view, highlight a video thumbnail (). Tap OK or  (Play slide show).

Play a slide show

There are two ways to start a slide show on your frame:

- Turn on the frame, then insert a card or connect a USB device—a new slide show starts automatically, replacing a currently running slide show or single view picture.
- Highlight a picture (in thumbnail or single view), or highlight a picture source on the Pictures and Videos screen, then tap  (Play slide show).

NOTE: A slide show plays continuously until you stop it or turn off the frame.

Music and videos in the same picture source play automatically during a slide show.

To prevent music from playing automatically, tap Settings > Slide show options > Music auto-play > Off.

Save your favorite slide show for easy access

Save the location of your favorite pictures as a slide show for easy access. While viewing a slide show:

- Tap  (Slide show options) → Save as My Slide show → OK. Tap Yes to confirm.

NOTE: My Slide show plays automatically when you turn on your frame. The My Slide show icon () appears on the Pictures and Videos screen as a picture source (see [page 16](#)).

Selecting multiple pictures

Use the multi-select feature to copy or delete two or more pictures or to play a slide show of highlighted pictures.

Select one at a time

- 1 In thumbnails view, slide along the bottom touch border to find a picture, then tap  (Select). A check mark appears on the selected picture.
- 2 Continue selecting pictures.



To remove a check mark, tap Unselect while the picture is highlighted.

Select/Unselect all



- In thumbnails view ([page 17](#)), tap Select All.
- To remove all check marks, tap Unselect All.

Playing music

Play music without pictures

- 1 Tap  (Home), then  (Music).
- 2 Slide right/left to move up or down the music source list, then tap OK.
- 3 Slide right/left to go to the previous or next song, or select All, then tap Play.
- 4 Adjust the volume with the Volume button on top of the frame.

NOTE: Music plays automatically when a memory card or USB device with music on it is connected.

To play background music with a slide show: with a slide show playing, tap  (Slide show options), then tap Background Music. Use the slider to navigate to the music or song you want to play, then tap Play. Tap  (Play slide show) to resume the slide show.

Automatically receiving My Friends' Albums

Your wireless frame uses the Picture Mail feature to automatically notify you () when a friend shares pictures with you at the KODAK Gallery. Play a slide show of the new pictures, right on your frame, even before you see the email on your computer!

To see the shared pictures right away:







- When the notice  appears on the frame screen, tap below View now.

A slide show of the new pictures plays on your frame. If there are multiple albums you haven't viewed yet, select a marked album  from the Gallery list that appears and tap OK.

To see the shared pictures later:



- 1 When the notice  appears on the frame screen, slide to choose Dismiss.
- 2 To see the new pictures, tap  (Home), highlight  (KODAK Gallery), then tap OK.
- 3 With My Friends' Albums highlighted, tap OK.
- 4 Highlight a marked album , then tap OK.

You can customize how and if you receive the notifications. See the extended user guide at www.kodak.com/go/digitalframesupport.

Adding a matte and faceplate

Customize your frame with a decorative matte and/or faceplate (packaged with some frames). Additional mattes and faceplates are available for purchase.

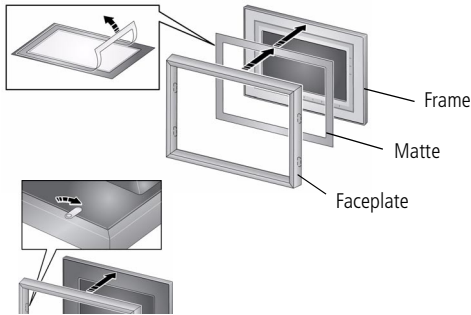

When you are not using the matte, reapply it to the liner and store in a plastic bag to keep the adhesive backing clean.

See page 25 to maintain your frame and faceplate.

Learning more about your frame

www.kodak.com/go/digitalframes

Purchase frame accessories, including decorative faceplates and custom mattes

www.kodak.com/go/digitalframesupport

Extended user guide

Interactive troubleshooting and repairs

Interactive tutorials

Frequently asked questions

Downloads

Product registration

4

Solving frame problems

For step-by-step product support, visit www.kodak.com/go/digitalframesupport and select Interactive Troubleshooting & Repairs. Or open EASYSHARE Digital Display Software on your computer and click Tools → Wireless Troubleshooter.

Troubleshooting wireless network connection

| Problem | Possible causes and/or solutions |
|--|---|
| Frame cannot connect to the wireless network — “Wireless network not found” appears. | <ul style="list-style-type: none">■ Make sure you have a wireless router and that it is broadcasting the SSID, or enter the SSID manually.■ Make sure you are within the operating range of the network. Move the frame into the same room with the router.■ Make sure your frame is using the latest firmware. Check www.kodak.com/go/digitalframesupport for updates.■ If your network security is enabled, see page 8 to enter your security key (WEP or WPA). The person who set up your network can help you with this information. |
| Cannot set up or view Web content wirelessly. | <ul style="list-style-type: none">■ Install the software that came with your frame (see page 10).■ Make sure your frame is connected to your wireless network (see page 13). <p>For more possible causes/solutions, see Troubleshooting in the extended user guide at www.kodak.com/go/digitalframesupport.</p> |

Troubleshooting frame problems

| If... | Try one or more of the following |
|---|---|
| Frame does not turn on. | <ul style="list-style-type: none"> ■ Make sure the power cable that was included with your frame is connected securely (see page 3). ■ Press and hold the power button for 2 seconds, then release (see page 3). ■ Unplug the power cable for 5 seconds, then reconnect the cable. Press and hold the power button for 2 seconds, then release. |
| Nothing happens when a memory card, camera, computer, or USB device is connected. | <ul style="list-style-type: none"> ■ Make sure the USB cable that was included with your camera or USB device is connected securely (see page 6). ■ Insert a certified CF/SD/MMC/MS/xD card with images into the designated card slot, then push to seat it (see page 6). Make sure the card (in the top slot) is flush with the frame surface. <p>NOTE: Do not insert a SANDISK Memory Stick PRO DUO card or other micro or mini memory card without an adapter. A large picture/video file may take time to appear.</p> |
| Touch border doesn't work. | <ul style="list-style-type: none"> ■ Unplug the power cable for 5 seconds, then reconnect the cable. Press and hold power the button for 2 seconds, then release (see page 3). ■ Use your finger to touch along the raised guide at the bottom and right border (see page 4). LED lights indicate touch points. |
| Frame freezes up or doesn't work properly. | <ul style="list-style-type: none"> ■ Unplug the power cable for 5 seconds, then reconnect the cable. Press and hold the power button for 2 seconds, then release. ■ Press the Volume and Power buttons at the top of the frame (see page 2) at the same time, then tap Yes to reset the frame. (Resetting your frame does not erase your saved files.) |

5 Appendix

Important safety instructions



CAUTION:

Do not disassemble this product; there are no user-serviceable parts inside. Refer servicing to qualified service personnel. Do not expose this product to liquid, moisture, or extreme temperatures. The use of controls, adjustments, or procedures other than those specified herein may result in exposure to shock and/or electrical or mechanical hazards. If the LCD breaks, do not touch the glass or liquid. Contact Kodak customer support.



CAUTION:

When using this product, it should be installed and operated with a minimum distance of 7.9 in. (20 cm) for 2.4 GHz operations between the radiator and your body. This transmitter must not be collocated or operated in conjunction with any other antenna or transmitter.

- The use of an accessory that is not recommended by Kodak may cause fire, electric shock, or injury. For approved accessories, visit www.kodak/go/accessories.
- Digital frame battery (internal and non-removable) may include perchlorate material. Special handling may apply in California.
- Use only a Leader Electronics Inc. AC adapter, model MU18-2120150-A1, 12-volt, 1.5 amp. In Europe, use only a Phihong AC adapter, model PSA 18R-120P. Use of other AC adapters may damage the frame and void your warranties.
- When displayed with the stand extended, the frame rests at a 68 - 90 degree angle.
- Do not place frame near naked flame sources such as lighted candles or heaters.
- Excessive sound pressure from earphones and headphones may cause hearing loss.

Upgrading your software and firmware

Download the latest versions of the software and the frame firmware (the software that runs on the frame). See www.kodak.com/go/digitalframedownloads.

Care and maintenance

Important: *Always disconnect the power before cleaning. Do not use water, cleaning solutions, or other adhesives on the frame or any of its parts.*

- **Gently** wipe the frame, LCD, matte, or faceplate with a clean, dry, lint-free cloth (included). For fingerprints on the frame, apply light pressure.
- Do not use cleaning solutions unless designed specifically for LCD screens. Do not allow chemicals, such as suntan lotion, to contact painted surfaces.
- Service agreements are available in some countries. Contact a dealer of Kodak products for details.
- For digital frame disposal or recycling information, contact your local authorities. In the US, visit the Electronics Industry Alliance Web site at www.eiae.org or visit www.kodak.com/go/digitalframesupport.

Limited warranty

Kodak warrants Kodak consumer electronic products and accessories ("Products"), excluding batteries, to be free from malfunctions and defects in both materials and workmanship for one year from the date of purchase. Retain the original dated sales receipt. Proof of the date of purchase will be required with any request for warranty repair.

Limited warranty coverage

Warranty service is only available from within the country where the Products were originally purchased. You may be required to ship Products, at your expense, to the authorized service facility for the country where the Products were purchased. Kodak will repair or replace Products if they fail to function properly during the warranty period, subject to any conditions and/or limitations stated herein. Warranty service will include all labor as well as any necessary adjustments and/or replacement parts. If Kodak is unable to repair or replace a Product, Kodak will, at its option, refund the purchase price paid for the Product provided the Product has been returned to Kodak along with proof of the purchase price paid. Repair, replacement, or refund of the purchase price are the sole remedies under the warranty. If replacement parts are used in making repairs, those parts may be remanufactured, or may contain remanufactured materials. If it is necessary to replace the entire Product, it may be replaced with a remanufactured Product. Remanufactured Products, parts and materials are warranted for the remaining warranty term of the original Product, or 90 days after the date of repair or replacement, whichever is longer.

Limitations

This warranty does not cover circumstances beyond Kodak's control. This warranty does not apply when failure is due to shipping damage, accident, alteration, modification, unauthorized service, misuse, abuse, use with incompatible accessories or attachments (such as third party ink or ink tanks), failure to follow Kodak's operation, maintenance or repacking instructions, failure to use items supplied by Kodak (such as adapters and cables), or claims made after the duration of this warranty. Kodak makes no other express or implied warranty for this product, and disclaims the implied warranties of merchantability and fitness for a particular purpose. In the event that the exclusion of any implied warranty is ineffective under the law, the duration of the implied warranty will be one year from the purchase date or such longer period as required by law. The option of repair, replacement, or refund is Kodak's only obligation. Kodak will not be responsible for any special, consequential or incidental damages resulting from the sale, purchase, or use of this product regardless of the cause. Liability for any special, consequential or incidental damages (including but not limited to loss of revenue or profit, downtime costs, loss of the use of the equipment, cost of substitute equipment, facilities or services, or claims of your customers for such damages resulting from the purchase use or failure of the Product), regardless of cause or for breach of any written or implied warranty is expressly disclaimed.

Your rights

Some states or jurisdictions do not allow exclusion or limitation of incidental or consequential damages, so the above limitation or exclusion may not apply to you. Some states or jurisdictions do not allow limitations on how long an implied warranty lasts, so the above limitation may not apply to you. This warranty gives you specific rights, and you may have other rights which vary from state to state or by jurisdiction.

Outside the United States and Canada

In countries other than the United States and Canada, the terms and conditions of this warranty may be different. Unless a specific Kodak warranty is communicated to the purchaser in writing by a Kodak company, no warranty or liability exists beyond any minimum requirements imposed by law, even though defect, damage, or loss may be by negligence or other act.

FCC compliance and advisory



KODAK EASYSHARE W820/W1020 wireless digital frames

This equipment has been tested and found to comply with the limits for a Class B digital device, pursuant to Part 15 of the FCC Rules. These limits are designed to provide reasonable protection against harmful interference in a residential installation.

This equipment generates, uses, and can radiate radio frequency energy and, if not installed or used in accordance with the instructions, may cause harmful interference to radio communications. However, there is no guarantee that interference will not occur in a particular installation.

If this equipment does cause harmful interference to radio or television reception, which can be determined by turning the equipment off and on, the user is encouraged to try to correct the interference by one or more of the following measures: 1) reorient or relocate the receiving antenna; 2) increase the separation between the equipment and the receiver; 3) connect the equipment to an outlet on a circuit different from that to which the receiver is connected; 4) consult the dealer or an experienced radio/TV technician for additional suggestions.

Any changes or modifications not expressly approved by the party responsible for compliance could void the user's authority to operate the equipment. Where shielded interface cables have been provided with the product or specified additional components or accessories elsewhere defined to be used with the installation of the product, they must be used in order to ensure compliance with FCC regulation.

FCC and Industry Canada

This device complies with Industry Canada RSS-210 and FCC Rules. Operation is subject to the following two conditions: (1) this device may not cause harmful interference, and (2) this device must accept any interference received, including interference that may cause undesired operation.

FCC et Industrie Canada

Cet appareil est conforme à la norme RSS-210 d'Industrie Canada et aux réglementations de la FCC. Son utilisation est soumise aux deux conditions suivantes : (1) cet appareil ne doit pas provoquer d'interférences nuisibles, et (2) cet appareil doit supporter les interférences reçues, y compris celles susceptibles de nuire à son bon fonctionnement.



| CE ¹⁵⁸⁸ | | ! | | R&TTE Directive 1999/5/EC | | | | | |
|--------------------|---|----|---|---------------------------|---|----|---|----|---|
| BE | ✓ | DK | ✓ | GR | ✓ | ES | ✓ | FR | ✓ |
| IE | ✓ | IT | ✓ | LU | ✓ | NL | ✓ | AT | ✓ |
| PT | ✓ | FI | ✓ | SE | ✓ | UK | ✓ | NO | ✓ |
| DE | ✓ | BG | ✓ | PL | ✓ | HU | ✓ | SK | ✓ |
| CZ | ✓ | EE | ✓ | RO | ✓ | CY | ✓ | LT | ✓ |
| LV | ✓ | MT | ✓ | SL | ✓ | | | | |

Appendix

Hereby, Eastman Kodak Company declares that this Kodak product is in compliance with the essential requirements and other relevant provisions of Directive 1999/5/EC.

This digital picture frame (W820 or W1020) transmits in 10 dBm. In France, the power level is limited to 10dBm in outdoor environments, per regulations. When in France, use the wireless functions of this device indoors only.

Canadian DOC statement

DOC Class B Compliance—This Class B digital apparatus complies with Canadian ICES-003.

Observation des normes-Classe B—Cet appareil numérique de la classe B est conforme à la norme NMB-003 du Canada.

Waste Electrical and Electronic Equipment labeling



EU: It is the final user's responsibility to discard this equipment into an approved, segregated collection scheme to enable its suitable treatment/disposal and to improve human/environmental protection. For more information, see your retailer, local authority, or www.kodak.com/go/recycle.

Australian C-Tick



N137

MPEG-4

Use of this product in any manner that complies with the MPEG-4 visual standard is prohibited, except for use by a consumer engaging in personal and non-commercial activities.

China RoHS

环保使用期限 (EPUP)

在中国大陆，该值表示产品中存在的任何危险物质不得释放，以免危及人身健康、财产或环境的时间期限（以年计）。该值根据操作说明中所规定的产品正常使用而定。

Environmental Protection Use Period (EPUP)

In China, this number indicates the time period (in years) within which any hazardous substances present in the product are not expected to be released such that there is risk to human health, property, or the environment. This value is assigned based on normal use of the product as described in the operating instructions.

Product Disclosure Table

有毒有害物质或元素名称及含量标识表
table of hazardous substances' name and concentration

| 部件名称 Component name | 有毒有害物质或元素 hazardous substances' name | | | | | |
|---|---|-----------|-----------|---------------|---------------|------------------|
| | 铅 (Pb) | 汞 (Hg) | 镉 (Cd) | 六价铬 (Cr6+) | 多溴联苯 (PBB) | 多溴二苯 醚 (PBDE) |
| 数码相架电路板元件 (Digital Photo Frame circuit board components) | X | O | O | O | O | O |
| 控制器 (Controller) | X | O | O | O | O | O |
| 交流变压器电路板元件 (AC Adapter circuit board components) | X | O | O | O | O | O |

○：表示该有毒有害物质在该部件所有均质材料中的含量均在SJ/T 11363-2006规定的限量要求以下。
 ×：表示该有毒有害物质至少在该部件的某一均质材料中的含量超出SJ/T 11363-2006规定的限量要求。
 ○：indicates hazardous substance concentration lower than MCV
 ×：indicates hazardous substance concentration higher than MCV



USB 数据线

Licensing

Supply of this product does not convey a license nor imply any right to distribute content created with this product in revenue-generating broadcast systems (terrestrial, satellite, cable and/or other distribution channels), streaming applications (via Internet, intranets and/or other networks), other content distribution systems (pay-audio or audio-on-demand applications and the like) or on physical media (compact discs, digital versatile discs, semiconductor chips, hard drives, memory cards and the like). An independent license for such use is required. For details, please visit <http://mp3licensing.com>.

Kodak

Eastman Kodak Company

Rochester, New York 14650

© Eastman Kodak Company, 2008

Kodak and EasyShare are trademarks of Eastman Kodak Company.

Eastman Kodak Company is an authorized licensee of the CompactFlash trademark.

4H5028_en